

**V O L V O**



**V O L V O**

DIPLOMATIC  
SALES

**VOLVO XC40**  
PURE ELECTRIC



p 3	Volvo XC40 Pure Electric offer
p 4-5	Standard equipment Core
p 6	Trim levels
p 7	Exterior
p 8-9	Interior
p 10	Wheels
p 10	Options
p 11	Option and accessory packs
p 12-13	Accessories
p 14	Extended Services
p 15	Delivery Pack
p 16	Technical specifications
p 17	Volvo Care Offer

MADE BY  
**SWEDEN** | BUILT IN  
**BELGIUM**

## VOLVO XC40 PURE ELECTRIC OFFER

	Number of engines	Motricity	Capacity hp/kW	Battery capacity nominal/usable kWh	Electric range up to km	Electric consumption kWh/100 km	Max power DC charging kW	List price € excl. VAT	List price € incl. VAT BE	List price € incl. VAT LU <sup>(1)</sup>
<b>CORE</b>										
Recharge	One engine	RWD	238/175	69/66	475	16,7	135	<b>43.347,11</b>	52.450	50.716
Recharge Extended Range	One engine	RWD	252/185	82/79	572	16,7	205	<b>45.000,00</b>	54.450	52.650
<b>PLUS</b>										
Recharge	One engine	RWD	238/175	69/66	473	16,8	135	<b>46.280,99</b>	56.000	54.149
Recharge Extended Range	One engine	RWD	252/185	82/79	570	16,8	205	<b>47.933,88</b>	58.000	56.083
Recharge Twin	Two engines	AWD	408/300	82/79	535	17,7	205	<b>51.487,60</b>	62.300	60.240
<b>ULTIMATE</b>										
Recharge Extended Range	One engine	RWD	252/185	82/79	565	16,9	205	<b>50.537,19</b>	61.150	59.129
Recharge Twin	Two engines	AWD	408/300	82/79	531	17,8	205	<b>54.090,91</b>	65.450	63.286

**Vehicles destined for EEA.** The models listed above are destined for the European Economic Area ('EEA') market. Volvo Cars does not guarantee the compatibility of these models with any rules or regulations applicable outside the EEA. If you export these models outside of the EEA or if you request us to do so for you, such export will take place at your own risk.

**Export of vehicles.** Export outside of the country of purchase in any event occurs at your risk and cost. The prices listed above are exclusive of freight charges, taxes, licenses and any other documentation related to the export of your vehicle outside of the country of purchase. In case of export, the dealer will request you to deposit the amount of VAT applicable in the country of purchase as a guarantee. The dealer will reimburse the relevant amount to you upon receipt of (i) proof that you are exempted from VAT in the country where the vehicle is registered, or (ii) proof that VAT has been paid in the country where the vehicle is registered.

**(1) Prices.** A delivery fee of € 250 (excl. VAT) will be added to the prices listed above for vehicles supplied in the Grand Duchy of Luxembourg. The above-listed prices are furthermore exclusive of dealer preparation fees. Therefore, additional charges may be applied at your delivery point. Finally, you will be responsible for the payment of VAT (as applicable in the country of first registration of your vehicle) and any other taxes, as well as any registration and similar fees, all to the extent applicable. For ease of reference, VAT as currently applicable in Belgium and the Grand Duchy of Luxembourg are listed above.

**MAINTENANCE AND REPLACEMENT OF WEAR & TEAR PARTS\*  
5 YEARS OR 150.000 KM**  
(whichever comes first)

**FACTORY WARRANTY ON YOUR VOLVO  
3 YEARS OR 100.000 KM**  
(whichever comes first)

**FACTORY WARRANTY ON HIGH VOLTAGE BATTERY\*\*  
8 YEARS OR 160.000 KM**  
(whichever comes first)

\* The Volvo Care Offer 'Service & Maintenance for Volvo Pure Electric' applies to the vehicle specified above, and for a period of **5 years from the date of delivery or 150.000 km** (whichever comes first). The Volvo Care Offer 'Service & Maintenance for Volvo Pure Electric' covers periodic maintenance services, every 24 months or every 30.000 km (whichever comes first), and includes replacement of the wear and tear parts listed below.

- Volvo Car Genuine Service at scheduled service intervals
- health check
- air filter replacement
- tyre sealant replacement in accordance with the prescribed interval
- cleaning of the sensors and cameras for the safety systems under the windscreen
- software updates
- **Includes** replacement of the following wear and tear parts: brake pads and discs (when required) and windscreen wiper blades (1x per year).
- **Excludes** replacement of wear and tear parts not explicitly mentioned above.

For more information about the Volvo Care Offer 'Service & Maintenance for Volvo Pure Electric', see page 17 of this price list.

\*\* The batteries undergo normal wear depending on age and use. If the battery capacity falls below 70% of the original state within 8 years from the date of delivery or 160.000 km (whichever is reached first), the battery will be replaced under guarantee.



## STANDARD EQUIPMENT CORE

### SAFETY

Stability and traction control: Electronic Stability Control (ESC) including Active Yaw Control, Understeer Control Logic, Advanced Stability Control, Roll Stability Control, Driver Steering Recommendation, Dynamic Torque Vectoring, Trailer Stability Assist (only with the tow bar) and Hill Descent Control | Traction Control (TC) including Corner Traction Control with Torque Vectoring | Spin Control including Engine Drag Control

Advanced Driver Assist System (ADAS) sensor platform

City Safety system: helps the driver to avoid or attenuate collisions with other vehicles (including those coming in the opposite direction at crossroads), cyclists, pedestrians (active up to a speed difference of 50 km/h, day and night), including active braking assistance

Cruise control

Lane Keeping Aid: helps the driver to stay in lane (active from 65 km/h), including Run-off Road Mitigation: helps prevent the vehicle from running off the road, with steering aid and braking intervention (active between 65 and 140 km/h)

Oncoming Lane Mitigation: helps the driver to avoid collisions with vehicles coming in the opposite direction by automatically adjusting the steering

Driver Alert Control (DAC): system that detects and warns of tiredness

Connected Safety technology including Slippery Road Alert and Hazard Light Alert

Automatic braking after a collision

Indirect Tyre Pressure Monitoring System (iTTPMS)

Ultra-resistant structure of vehicle interior and roof in boron steel

Collapsible steering column

Automatic unlocking after a collision

Height-adjustable seat belts in front and with pre-tensioners and load limiters front and rear

Front airbags including driver's knee airbag, SIPS® side airbags and inflatable curtains

WHIPS® (Whiplash Injury Protection System): provides protection against injuries due to whiplash thanks to specific energy-absorbing backrests and seats and head restraints integrated into the front seats

Brake Pedal Release: automatic release of brake pedal, by means of a pyrotechnic device, in the event of an accident to attenuate injuries to feet, legs and back

Emergency brake lights

Power-operated child safety lock on rear doors

Isofix anchorages for the front passenger seat and the outer positions of the rear seat

Front passenger airbag cut-off switch

Acoustic Vehicle Alerting System (AVAS) at low speed

### DRIVER ASSISTANCE

Road Sign Information (RSI) with Speed Limiter: display of road sign information with excess speed warning

Ready to Drive notification: function that informs the driver via a sound and a visual notification if the vehicle is still standing still even though the vehicle in front has moved a certain distance or exceeded a certain speed

### PERSONAL SAFETY AND CONVENIENCE

Convenient Entry and Start that among other things eliminates the need of a start button. When the driver is seated, the car starts as he/she presses the brake pedal and engages Drive or Reverse

Welcome lighting when the driver is approaching the car

One Pedal Drive: possibility to use only one pedal to accelerate or brake. Just by lifting the pedal the driver can, on a short distance, slow the car all the way to standstill not having to use the brake pedal

Electric parking brake with Auto Hold (automatic brake at a standstill) and Hill Start Assist (assistance to start on a hill or slope) functions

Immobiliser

One remote control and one "Care Key" which allows you to set a lower maximal speed (<180 km/h)

Tyre repair kit in the Frunk

### CLIMATE CONTROL

Two-zone electronic automatic climate control system with air vents at the rear, humidity sensor, air recirculation function and pollen filter

Clean Zone: IAQS (Interior Air Quality System) to improve air quality inside the vehicle, with active filter

Interior climate preconditioning (cabin cooling or heating)

Front wipers blades with integrated washers ("Aquablades")

Rain sensor with adjustable sensitivity level

### INTERIOR

Textile City Canvas upholstery

Comfort front seats with manual adjustable height and length and manual seat cushion extension

Adjustable driver seat cushion incline

Power-operated four-way lumbar support

Rear seats with central armrest with cup holder, load hatch and folding back in two parts (60/40)

Charcoal central console at front with armrest and large storage compartment, two cup holders and two open storage compartments

High Gloss Black finish on the central console and centre display trim and the front air vents

Charcoal Origin inlays in the dashboard and the front doors

Interior lighting Plus, including vanity mirrors with light at front, front reading lights, dimmed lighting at front and floor lights at front

Black headlining

Inner rear-view mirror with automatic dimming

Black leather-free sport steering wheel with Silk Metal Inlay

Black sport simili-leather gear lever knob

Aluminium door sills at front

Textile floor mats at front and rear in Charcoal Melange

### VERSATILITY

Frunk: 31 liter front load compartment

Very spacious storage bins in front doors

2 USB-C connections at the front of the central console and two at the back

Removable litter bin with lid in the central console

Ticket holder on driver's side of the windscreen

Folding hook in the glove compartment lid to hang small bags

Storage pockets in backrest of front seats

Flat load floor with bench seat back folded down

Rigid, detachable luggage cover, that can be stored beneath the luggage compartment floor

Storage space beneath the luggage compartment floor

Four shopping bag hooks and four folding load retainer eyelets in luggage compartment

---

## STANDARD EQUIPMENT CORE

---

---

### MULTIMEDIA & CONNECTIVITY

New generation 12,3" driver information display with two new display modes : Calm and Navi

9" central touchscreen to control most of the functions

Google infotainment system with :

- Google Maps: navigation and public charging stations locator

- Google Assistant: voice assistant via "Hey Google" to control certain car functions, navigation, your smartphone, media, search for online information or control certain connected devices

- Google Play Store: access to a catalog of in-car apps to download and use in the car (such as Spotify®, Waze®, Amazon Prime Video® and YouTube®)

4-year data subscription for use of Google services and all apps. After that period, a paid extension of the data subscription will be available or you can share your data via your smartphone

Remote functions via the Volvo Cars app on your smartphone, such as:

- launch and plan the preconditioning to cool/heat the cabin to comfort temperature and optimize your battery before departure

- (un)lock your car

- localize your car

- access to the Driving Journal

- plan and check the status of your electric charging session

Smartphone integration (Apple CarPlay®) | Access to third developers apps such as Spotify®, Waze®, Google Maps® and WhatsApp®

Wireless charging for smartphone in the front storage compartment (electromagnetic induction technology)

High Performance audio system with 8 speakers (1 full-range and 1 air woofer beneath the windscreen, 2 tweeters in front and 4 mid-range front and rear) and High Performance 250 W amplifier

Controls integrated into steering wheel for driver display, cruise control, audio, phone, navigation system and voice commands

DAB+ (Digital Audio Broadcasting)

Integrated "SOS" button for assistance in life-threatening emergencies

Integrated "On Call" button for roadside assistance

Volvo Assistance | 3 years subscription included

### EXTERIOR

16A 3-phase charging cable, Mode 3, with Mennekes socket (for charging point), length 6 m

10A charging cable with Schuko socket (for domestic use), length 7 m

Charging port located in the left rear wing

11 kW onboard charger (AC-DC converter)

Covered grille with body coloured grille frame

LED headlights with integrated T-shaped daytime running lights, automatic level adjustment, Active High Beam and Volvo Safety Lights

19" 5 spoke Black/Diamond Cut alloy wheels

235/50 R19 front (all season) tyres, 255/45 R19 rear (all season) tyres

Dynamic chassis

Wheel arches and lower bodywork parts in Matt Black plastic

Power retractable heated outer rear-view mirrors with integrated LED indicator. With automatic dimming

Roof and rear-view mirror caps in contrasting Solid Black (not applicable to Silver Dawn Metallic and in Onyx Black with Onyx Black Metallic exterior colour)

High Gloss Black trim on lower part of side windows

Front and rear Glossy Black skidplates

Glossy Black integrated roof rails

Rear Park Assist Camera

Rear and Front Park Assist

---





---

## TRIM LEVELS

---

### PLUS

Includes the XC40 Core equipment supplemented by the specific Plus equipment

---

Heated front seats

---

Heated steering wheel

---

Heat pump

---

Air purifier (incl. Advanced filter, AQS and PM 2.5 sensor) which removes up to 80% of all harmful PM 2.5 particles and pollen from the air in the car. Control and statistics via the central display or the Volvo Cars app

---

Volvo Guard alarm with movement and inclination sensor

---

Multifunction folding load floor with shopping bag hook

---

Nylon safety net between the rear seats and the luggage compartment

---

Keyless Entry: passive (un)locking, hands-free tailgate opening/closing (foot movement under the rear bumper), LED entry light and lighting in the door handles

---

Power-operated tailgate

---

Adaptive Cruise Control that can support you to keep a set distance to the car in front at all speeds

---

Pilot Assist that together with Adaptive Cruise Control enables empowered driving on motorways and roads with side ground marking up to a speed of 130 km/h. Also includes Emergency Stop Assist function that can bring the vehicle to a complete stop in lane in situations where the driver is not responding to hands-off warnings

---

Advanced safety alert and intervention system, including BLIS (Blind Spot Information System with steering assistance), Rear Collision Warning with automatic emergency braking, Prepared Front Safety Belts and Cross Traffic Alert (detection of vehicles coming from the side when reversing)

---

### ULTIMATE

Includes the XC40 Plus equipment supplemented by the specific Ultimate equipment

---

Power-operated driver seat with memory function for seat position and external rear-view mirrors

---

Power-operated front passenger seat

---

Power folding of the rear headrests

---

Harman Kardon audio system with 13 loud speakers (1 full-range and 1 air woofer beneath the windscreen, 2 tweeters, 4 mid-range, 2 woofers, 2 full-range surround and 1 ventilated subwoofer) and 660 W amplifier

---

360° Park Assist Camera with bird's-eye view

---

Rear, Front and Side Park Assist

---

Tilt and slide panoramic sunroof with integrated power-operated sun curtain

---

LED front fog lights









---

High-pressure headlight washers

---



## EXTERIOR

		List price € excl. VAT	List price € incl. VAT BE	List price € incl. VAT LU	CORE	PLUS	ULTIMATE
<b>SOLID PAINT*</b>							
	626 Cloud Blue	<b>739,67</b>	895	865	O	O	O
<b>METALLIC PAINT*</b>							
	735 Silver Dawn Metallic	<b>0,00</b>	0	0	●	●	●
	707 Crystal White Pearl	<b>739,67</b>	895	865	O	O	O
	717 Onyx Black Metallic	<b>739,67</b>	895	865	O	O	O
	733 Sage Green Metallic	<b>739,67</b>	895	865	O	O	O
	734 Fjord Blue Metallic	<b>739,67</b>	895	865	O	O	O
	736 Bright Dusk Metallic	<b>739,67</b>	895	865	O	O	O
	740 Vapour Grey Metallic	<b>739,67</b>	895	865	O	O	O

\*Roof in Solid Black, except with exterior colours Onyx Black Metallic (roof in Onyx Black) and Silver Dawn Metallic (roof in Silver Dawn)

O = Option | ● = Included in trim level

# INTERIOR

		List price € excl. VAT	List price € incl. VAT BE	List price € incl. VAT LU	CORE	PLUS	ULTIMATE
<b>COMFORT SEATS, TEXTILE CITY CANVAS</b>							
<b>R780</b>	Interior base colour: Charcoal Colour seats: Charcoal Colour headlining: Charcoal Dashboard and front door inlays: Origin (Charcoal)	<b>0,00</b>	0	0	●	●	●
<b>COMFORT SEATS, MICROTECH/OPEN GRID TEXTILE</b>							
<b>RN80</b>	Interior base colour: Charcoal Colour seats: Charcoal Colour headlining: Charcoal Dashboard and front door inlays: Topography, back-lit Interior lighting Pro: includes among others vanity mirrors with light, front and rear reading lights, floor lights at front, load compartment lighting, dimmed lighting at front and rear	<b>1.570,25</b>	1.900	1.837	0	0	0
<b>COMFORT SEATS, CONNECT NUBUCK TEXTILE/MICROTECH</b>							
<b>R980</b>	Interior base colour: Charcoal Colour seats: Charcoal Colour headlining: Charcoal Colour dashboard and front door inlays: Topography, back-lit Interior lighting Pro: includes among others vanity mirrors with light, front and rear reading lights, floor lights at front, load compartment lighting, dimmed lighting at front and rear	<b>1.322,31</b>	1.600	1.547	0	0	0
<b>Y980*</b>	Interior base colour: Charcoal/Fjord Blue Colour seats: Charcoal Colour headlining: Charcoal Colour dashboard and front door inlays: Topography, back-lit Colour carpets: Fjord Blue Interior lighting Pro: includes among others vanity mirrors with light, front and rear reading lights, floor lights at front, load compartment lighting, dimmed lighting at front and rear	<b>1.528,93</b>	1.850	1.789	0	0	0
<b>COMFORT SEATS, WOLMIX</b>							
<b>R8Z0</b>	Interior base colour: Charcoal Steering wheel base colour: Charcoal Colour seats: Midnight Zink Colour headlining: Charcoal Dashboard and front door inlays: Topography, back-lit Crystal gearshifter Interior lighting Pro: includes among others vanity mirrors with light, front and rear reading lights, floor lights at front, load compartment lighting, dimmed lighting at front and rear	<b>1.900,83</b>	2.300	2.224	0	0	0

\*Not with Sage Green Metallic (733)

0 = Option | ● = Included in trim level





R780



RN80





R980



Y980



## WHEELS

		List price € excl. VAT	List price € incl. VAT BE	List price € incl. VAT LU	CORE	PLUS	ULTIMATE
<b>19" ALLOY WHEELS</b>							
	- 19" 5 spoke Black/Diamond Cut 235/50 R19 Front all season tyres 255/45 R19 Rear all season tyres Tyre class A	<b>0,00</b>	0	0	●	●	●
<b>20" ALLOY WHEELS</b>							
	1185 20" 5 spoke Glossy Black/Diamond Cut 235/45 R20 Front all season tyres 255/40 R20 Rear all season tyres Tyre class A	<b>553,72</b>	670	648	O	O	O

O = Option | ● = Included in trim level

## OPTIONS

		List price € excl. VAT	List price € incl. VAT BE	List price € incl. VAT LU	CORE	PLUS	ULTIMATE
<b>EXTERIOR &amp; LIGHTING</b>							
1170	Full LED headlights with Pixel technology, integrated T-shaped daytime running lights and adaptive high beam: each contains 84 pixel LEDs that switches on and off independently to optimise the light pattern without dazzling the other road users	<b>950,41</b>	1.150	1.112	-	-	O
179	Privacy glass for rear windows	<b>330,58</b>	400	387	O	O	O
<b>VERSATILITY</b>							
1028	Semi-automatic retractable tow bar with 13-pin outlet (Trailer Stability Assist system included)	<b>950,41</b>	1.150	1.112	O	O	O

O = Option | - = Not available



## OPTION AND ACCESSORY PACKS

	List price € excl. VAT	List price € incl. VAT BE	List price € incl. VAT LU	CORE	PLUS	ULTIMATE
<b>DRIVER ASSIST PACK</b>						
132   Driver Assistance: consists of Adaptive Cruise Control and Pilot Assist. Pilot Assist enables empowered driving on motorways and roads with side ground marking up to a speed of 130 km/h. Also includes Emergency Stop Assist function that can bring the vehicle to a complete stop in lane in situations where the driver is not responding to hands-off warnings						
603   Driver Awareness: advanced safety alert and intervention system, including BLIS (Blind Spot Information System with steering assistance), Rear Collision Warning with automatic emergency braking, Prepared Front Safety Belts and Cross Traffic Alert (detection of vehicles coming from the side when reversing)						
P0005	<b>950,41</b>	1.150	1.112	O	●	●
<b>WINTER PACK</b>						
11   Heated front seats						
869   Heated steering wheel						
1092   Heat pump						
P0008	<b>826,45</b>	1.000	967	O	●	●
<b>PROTECTION PACK</b>						
A00112   Moulded plastic load compartment protection						
A00492   Rubber floor mat front and rear						
A00217   Anti-theft wheel locks						
PA001	<b>239,67</b>	290	280	O	O	O
<b>TRAVEL PACK</b>						
A00104   Aluminium transversal roof bars						
A00111   Lock kit - one key system						
A01241   Roofbox 'Travel Active 500', glossy black (500L, 215x92x44 cm)						
PA002	<b>913,22</b>	1.105	1.068	O	O	O
<b>BICYCLE PACK</b>						
A00104   Aluminium transversal roof bars						
A00111   Lock kit - one key system						
A00025   Bicycle holder with frame bracket (aluminium), to be fitted on load carrier (1 bicycle)						
PA004	<b>363,64</b>	440	425	O	O	O
<b>CONVENIENCE PACK</b>						
A00087   Glasses holder						
A00761   Wool neck cushion (Charcoal)						
A00106   Luggage net to be attached to load securing eyelets						
A01247   Charging cable storage bag						
PA006	<b>161,16</b>	195	189	O	O	O

O = Option | ● Included in trim level

## ACCESSORIES

		List price € excl. VAT	List price € incl. VAT BE	List price € incl. VAT LU	CORE	PLUS	ULTIMATE
<b>RECHARGE</b>							
A01230	Wallbox (until 22 kW) standard installation included*	<b>1.896,69</b>	2.295	2.219	O	O	O
A01150	Charging cord 1P 10A with Schuko socket (for domestic use), length 7 metres	<b>342,98</b>	415	401	O	O	O
A01354	Charging cord 3P 16A with CEE socket (for red industrial socket, 5 pins), length 6 metres	<b>429,75</b>	520	503	O	O	O
A01152	Charging cord 1P 16A with CEE socket (for blue industrial socket, 3 pins), length 7 metres	<b>342,98</b>	415	401	O	O	O
A01355	Charging cord 3P 16A mode 3 (type 2) with Mennekes socket (for charging point), length 6 metres	<b>342,98</b>	415	401	O	O	O
A01154	Charging cord 1P 16A mode 3 (type 2) with Mennekes socket (for charging point), length 7 metres	<b>342,98</b>	415	401	O	O	O
A01247	Charging cable storage bag	<b>53,72</b>	65	63	O	O	O
<b>LUGGAGE COMPARTMENT</b>							
A00112	Moulded plastic load compartment protection	<b>119,83</b>	145	140	O	O	O
A00382	Textile/plastic reversible load compartment floor mat	<b>169,42</b>	205	198	O	O	O
A00106	Luggage net to be attached to load securing eyelets	<b>53,72</b>	65	63	O	O	O
A00189	Steel protective grille between the load compartment and the rear seat	<b>239,67</b>	290	280	O	O	O
<b>COMFORT</b>							
A00492	Rubber floor mat front and rear	<b>111,57</b>	135	131	O	O	O
A00744	Windscreen sunshade	<b>111,57</b>	135	131	O	O	O
A00087	Glasses holder	<b>45,45</b>	55	53	O	O	O
A00530	Ashtray	<b>33,06</b>	40	39	O	O	O
A00761	Wool neck cushion (Charcoal)	<b>53,72</b>	65	63	O	O	O
A00763	Nubuck neck cushion (Blond)	<b>53,72</b>	65	63	O	O	O
A00769	Wool cushion (Charcoal)	<b>53,72</b>	65	63	O	O	O
A01237	Tablet holder	<b>219,01</b>	265	256	O	O	O
<b>DESIGN</b>							
A00853	Roof spoiler	<b>392,56</b>	475	459	O	O	O
A00594	Illuminated tailgate scuff plate, Charcoal	<b>392,56</b>	475	459	O	O	O
<b>VERSATILITY</b>							
A00463**	Preparation for mounting tow bar as accessory	<b>0,00</b>	0	0	O	O	O
A00463**	Semi-automatic retractable tow bar with 13-pin outlet (Trailer Stability Assist system included)	<b>950,41</b>	1.150	1.112	O	O	O
A01238	Folding bicycle holder on tow bar for two bicycles (Fix4Bike)	<b>652,89</b>	790	764	O	O	O
A01239	Bicycle holder on tow bar for three bicycles (Fix4Bike)	<b>673,55</b>	815	788	O	O	O
A00017	Adapter for extra bike (only with A01239)	<b>119,83</b>	145	140	O	O	O
A00104	Aluminium transversal roof bars	<b>239,67</b>	290	280	O	O	O
A01240	Roofbox 'Travel 400', glossy black (400L, 175x87x46 cm)	<b>632,23</b>	765	740	O	O	O
A01241	Roofbox 'Travel Active 500', glossy black (500L, 215x92x44 cm)	<b>719,01</b>	870	841	O	O	O
A01399	Roofbox 'Travel Premier 430', glossy black (430L, 223x94x30 cm), with LED lighting	<b>913,22</b>	1.105	1.068	O	O	O
A00221	Ski holder, (4 pairs of skis) to mount on roof bars	<b>152,89</b>	185	179	O	O	O
A00219	Ski holder, (6 pairs of skis) to mount on roof bars	<b>198,35</b>	240	232	O	O	O
A01143	Ski holder, sliding, to be fitted on load carrier	<b>173,55</b>	210	203	O	O	O
A00025	Bicycle holder with frame bracket (aluminium), to be fitted on load carrier (1 bicycle)	<b>119,83</b>	145	140	O	O	O
A00111	Lock kit - one key system	<b>53,72</b>	65	63	O	O	O
<b>CHILD SAFETY</b>							
A00096	Kick guard with storage pockets	<b>53,72</b>	65	63	O	O	O
A01000	Easy access rearward facing child seat i-Size with Isofix (0-18 kg)	<b>595,04</b>	720	696	O	O	O
A00328	Child seat group 1/2 (9-25 kg), rearward facing	<b>342,98</b>	415	401	O	O	O
A00379	Booster seat with detachable backrest in wool (15-36 kg)	<b>219,01</b>	265	256	O	O	O
A00329	Child seat group 2/3 (15-36 kg) with Isofix anchorage	<b>285,12</b>	345	334	O	O	O

\* Indicative pricing for charging station with 1 fixed cable of 5m or socket and loadbalancing module. A standard installation includes an installation check by phone, wall or pole mounted (max 1 meter ground works), circuit breaker, fuses, 10m cable, 10m data cable, 10m tube, if necessary a supplementary small electricity cabinet, explanation, electric scheme, legal control. No demolition or excavation works included. Final price through tailor-made offer based on onsite visit.

\*\* Accessories that affect the weight and aerodynamics of the car, and therefore also the electricity consumption and the range measured according to the WLTP.

O = Option

## ACCESSORIES

		List price € excl. VAT	List price € incl. VAT BE	List price € incl. VAT LU	CORE	PLUS	ULTIMATE
<b>SECURITY &amp; PROTECTION</b>							
A01251	Mini remote control 'Sport Key'	<b>169,42</b>	205	198	0	0	0
A00604	Dog harness	<b>111,57</b>	135	131	0	0	0
A00217	Anti-theft wheel locks	<b>53,72</b>	65	63	0	0	0
A00164**	Front mud flaps	<b>74,38</b>	90	87	0	0	0
A00165**	Rear mud flaps	<b>74,38</b>	90	87	0	0	0
A00228	AutoSock (snow socks)	<b>99,17</b>	120	116	0	0	0
A00227	Centrax snow chains (for 19" and 20" wheels)	<b>326,45</b>	395	382	0	0	0
<b>WHEELS</b>							
A01311	Winter wheels with 19" 5-double-spoke Black Diamond Cut rims and 235/50 R19 - 255/45 R19 winter tyres	<b>2.272,73</b>	2.750	2.659	0	0	0
A01312	Winter wheels with 20" 5-spoke Black Diamond Cut rims and 235/45 R20 - 255/40 R20 winter tyres	<b>2.603,31</b>	3.150	3.046	0	0	0

\*\* Accessories that affect the weight and aerodynamics of the car, and therefore also the electricity consumption and the range measured according to the WLTP.

O = Option





## EXTENDED SERVICES

### VOLVO CAR EXTENDED WARRANTY

Drive with **peace of mind**

When you buy a Volvo, you are choosing top quality, safety and reliability. Not only because you are buying a quality vehicle, but also because your Volvo dealer offers you the best service.

An extension of the factory guarantee protects you against high costs in the event of unexpected defects. Thanks to the very comprehensive coverage, you can drive your Volvo for an additional 2 years without any worries when your Volvo manufacturer's warranty expires after 3 years.

Volvo Car Extended Warranty protects you against unforeseen repair costs, even after the Volvo manufacturer's warranty has expired.



#### GUARANTEED LIQUIDITY IN CASE OF REPAIRS

And extensive repair costs reimbursement outside the manufacturer's warranty

#### VALID ANYWHERE IN EUROPE

The extended warranty can also be transferred to the next owner

#### USE OF GENUINE VOLVO PARTS

And repaired by Volvo-trained personnel: your Volvo remains in optimal condition

		List price € excl. VAT	List price € incl. VAT BE	List price € incl. VAT LU	
<b>EXTENDED WARRANTY</b>					
A00139	Volvo Car Extended Warranty + 1 year, limited to 200.000 km	<b>392,56</b>	475	459	O
A00140	Volvo Car Extended Warranty + 2 years, limited to 200.000 km	<b>764,46</b>	925	894	O

O = Option

---

## DELIVERY PACK

---

### VOLVO CAR DELIVERY PACK

Enjoy a **personalized delivery**

The delivery of a new car is a special moment. And Volvo makes this moment even more special. With the Delivery Pack, we provide a personalized unveiling of your new Volvo followed by a detailed explanation during and after delivery. Of course, we make sure your car is fully roadworthy and equipped to enjoy the Volvo experience right away.



- 5 safety vests
- fire extinguisher
- warning triangle
- front numberplate

- car charged to at least 80%
- detailed explanation of all car features
- Volvo Cars app setup

- car delivered under cover with personalized nameplate
- 1 hour follow-up meeting for all your questions after delivery

	List price € excl. VAT	List price € incl. VAT BE	List price € incl. VAT LU
<b>DELIVERY PACK</b>			
DELIV01 Volvo Car Delivery Pack	<b>371,90</b>	450	435

## TECHNICAL SPECIFICATIONS

ENGINE	Recharge	Recharge Extended Range	Recharge Twin
Engine code	E400V16 (EP)	E400V8 (EH)	E400V12 (ER)
Engine type	One electric motor	One electric motor	Two electric motors
Electric engine battery	Lithium-ion	Lithium-ion	Lithium-ion
Battery energy capacity (nominal) kWh	69	82	82
Battery energy capacity (usable) kWh	66	79	79
Max. capacity kW/hp (rear engine)	175/238	185/252	190/258
Max. capacity kW/hp (front engine)	-	-	110/150
Max. torque Nm (rear engine)	420	420	420
Max. torque Nm (front engine)	-	-	250
Emissions standard	EURO 6d	EURO 6d	EURO 6d
<b>TRANSMISSION</b>			
Motricity	RWD	RWD	AWD
Gearbox	Single-speed	Single-speed	Single-speed
<b>PERFORMANCES</b>			
Acceleration 0-100 km/h (sec)	7,3	7,3	4,8
Top speed (km/h)	180	180	180
<b>RECHARGE</b>			
Max AC charging (kW)	11	11	11
Max DC charging (kW)	135	205	205
Charge time, 1-phase, AC, from 0 to 100% (32A/16A/10A) 230V (hours)	11/21/35	13/25/42	13/25/42
Charge time, 3-phase, AC, from 0 to 100% (16A/10A) (hours)	7/12	8/15	8/15
Charge time, DC, from 10 to 80% (200 kW/150 kW/50 kW fast charger) (min.)	-/34/62	28/29/68	28/29/68
<b>CONSUMPTION AND RANGE ACCORDING TO WLTP</b>			
Electric power consumption (combined) kWh/100km	16,7-17,4	16,7-17,4	17,7-18,3
Electric range (combined) km	475-459	572-550	535-518
<b>WEIGHTS AND MEASURES</b>			
Min. curb weight (kg)	1.959	2.001	2.092
Running order weight (kg)	2.040	2.075	2.170
Max. total weight (kg)	2.470	2.520	2.650
Max. weight braked/unbraked trailer (kg)	1.500/750	1.500/750	1.800/750
Max. roof load capacity (kg)	75	75	75
Largest load volume with bench seat back folded down ISO V214-1 (incl. V209) (liters)	1.295	1.295	1.295
Largest volume load compartment ISO V214-2 (incl. V209) (liters)	545	545	545
Volume load compartment under luggage cover ISO V211-2 (incl. V209) (liters)	419	419	419
Volume under load compartment floor ISO V209 (liters)	68	68	68

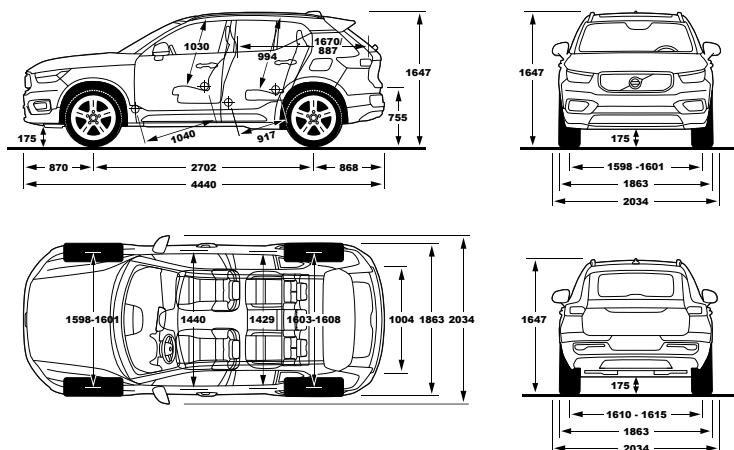

### DIMENSIONS

#### EXTERIOR

Length x width x height (driver included)	444,0 x 187,3 x 165,1 cm
Wheelbase	270,2 cm
Front track	160,1 cm
Rear track (with 19" rims/with 20" rims)	161,5/161,0 cm
Turning circle between curbs	11,4 m
Ground clearance (driver included)/fording depth	17,5/45,0 cm

#### INTERIOR

Headroom with sunroof front/rear	95,5 cm/97,4 cm
Headroom without sunroof front/rear	99,1 cm/99,4 cm
Shoulder room front/rear	144,0/142,9 cm
Leg room front/rear	104,0/91,7 cm
Length luggage compartment rear seats-tailgate	88,7 cm
Length luggage compartment front seats-tailgate	167,0 cm
Height luggage compartment	74,6 cm
Lifting height	75,5 cm
Width luggage compartment between wheel arches	100,4 cm
Min./max. width tailgate opening	94,7/105,9 cm

## VOLVO CARE OFFER FOR VOLVO PURE ELECTRIC

The Volvo Care Offer 'Service & Maintenance for Volvo Pure Electric' is included\* with the purchase of any new, all-electric Volvo. This page describes the services and parts included in the maintenance and service programme for these vehicles.

The Volvo Care Offer 'Service & Maintenance for Volvo Pure Electric' is valid for a period of **5 years from the date of delivery or 150.000 km** (whichever comes first). The vehicle owner can have the periodic maintenance of his/her Volvo Pure Electric carried out at the prescribed service intervals in any authorised Volvo workshop in Belgium or the Grand Duchy of Luxembourg.

Our in-house trained Volvo technicians maintain the vehicle and keep it in top condition. They also carry out a health check and verify whether the vehicle is equipped with the latest software.

The detailed terms and conditions applicable to this Volvo Care Offer 'Service & Maintenance for Volvo Pure Electric', including restrictions, will be handed over to the first owner of the vehicle by the Volvo retailer who delivers the vehicle. These will remain valid for the stated duration and mileage, even if there has been a change in ownership.

The Volvo Care Offer 'Service & Maintenance for Volvo Pure Electric' applies to the vehicle specified on page 3 in this price list, and for a period of **5 years from the date of delivery or 150.000 km** (whichever comes first). The Volvo Care Offer 'Service & Maintenance for Volvo Pure Electric' covers periodic maintenance services, every 24 months or every 30.000 km (whichever comes first), and includes replacement of the wear and tear parts listed below.

- Volvo Car Genuine Service at scheduled service intervals
  - health check
  - air filter replacement
  - tyre sealant replacement in accordance with the prescribed interval
  - cleaning of the sensors and cameras for the safety systems under the windscreen
  - software updates
- **Includes** replacement of the following wear and tear parts: brake pads and discs (when required) and windscreen wiper blades (1x per year).
  - **Excludes** replacement of wear and tear parts not explicitly mentioned above.

\* Volvo vehicles with specific service programmes (such as taxis, police vehicles or vehicles with other specific purposes) are not eligible for the Volvo Care Offer 'Service & Maintenance for Volvo Pure Electric' described above.

The 'Volvo Car Genuine Service' maintenance programme may be amended by Volvo Cars, provided that such amendment will not affect the application of the Volvo Cars warranty or affect the vehicle owner's rights under the Volvo Care Offer.

The inclusion of wear and tear parts in the Volvo Care Offer 'Service & Maintenance for Volvo Pure Electric' does not affect the reference to 'wear and tear' in the Service and Warranty Booklet.

The Volvo Care Offer 'Service & Maintenance for Volvo Pure Electric' is subject to the terms and conditions regarding service and maintenance. Should you have any questions about this, please do not hesitate to contact our Volvo retailers.

### VOLVO CARE OFFER GENERAL TERMS AND CONDITIONS 'SERVICE & MAINTENANCE FOR VOLVO PURE ELECTRIC'

#### 1. Application of the conditions

These Volvo Care Offer terms and conditions 'Service & Maintenance for Volvo Pure Electric' apply to new, all-electric Volvo vehicles. These terms and conditions form part of the purchase contract for the vehicle. Regardless of whether the vehicle is purchased from a Volvo Car Corporation entity or from a Volvo retailer, the Volvo National Sales Company or Volvo's importer in the country of first purchase is responsible for this service programme.

#### 2. Validity of the Volvo Care Offer 'Service & Maintenance for Volvo Pure Electric'

- The Volvo Care Offer 'Service & Maintenance for Volvo Pure Electric' is valid for a defined limited period of time, as previously stated and includes, where applicable, defined wear and tear parts of the vehicle, as previously specified. Any work carried out that is not covered by the Volvo Care Offer 'Service & Maintenance for Volvo Pure Electric' will remain the responsibility of the customer. When all required work has been carried out or when the limited validity period has expired, the Volvo Care Offer 'Service & Maintenance for Volvo Pure Electric' will end. The maintenance programme will also be considered terminated if maintenance should have been carried out in accordance with the prescribed maintenance intervals (as stated in the owner's manual and the Service and Warranty Booklet for the vehicle) but the vehicle has not been presented to an authorised Volvo workshop to carry out the Volvo Car Genuine Service.
- The Volvo Care Offer 'Service & Maintenance for Volvo Pure Electric' is linked to the market in which it was originally sold. The periodic maintenance of the vehicle according to the prescribed service intervals can only be carried out in the authorised Volvo workshops within that market.
- Volvo Cars has the right to terminate the Volvo Care Offer 'Service & Maintenance for Volvo Pure Electric' with immediate effect should the conditions of Volvo Cars' operations in the relevant market change significantly due to circumstances outside of Volvo Cars' control and should these circumstances make it very difficult for Volvo Cars to carry out the Volvo Care Offer 'Service & Maintenance for Volvo Pure Electric'. Both parties have the right to terminate the Volvo Care Offer 'Service & Maintenance for Volvo Pure Electric' with immediate effect should the other party be in serious or repeated breach of its obligations under these terms and conditions.

#### 3. Owner obligations

Periodic maintenance of the vehicle must be carried out according to Volvo Cars' recommendations. Volvo Car Genuine Service in accordance with the prescribed

service intervals, depends on time and annual mileage and may occur at different time intervals. The validity of the Volvo Care Offer 'Service & Maintenance for Volvo Pure Electric' further requires that the vehicle owner:

- Drives, maintains and manages the vehicle in accordance with the instructions in the vehicle owner's manual (extended version can be found at [volvocars.com](http://volvocars.com)) and in the Service and Warranty Booklet (included in the vehicle documents).
- Conducts routine checks of the fluid levels in the vehicle between recommended service intervals and, if necessary, fills up at its own expense.
- Delivers the vehicle, at its own expense, to an authorised Volvo workshop for maintenance in accordance with the service intervals specified in the owner's manual and the vehicle Service and Warranty Booklet.

#### 4. Transfer of the Volvo Care Offer 'Service & Maintenance for Volvo Pure Electric'

If the vehicle is sold or otherwise transferred to a new owner, the Volvo Care Offer 'Service & Maintenance for Volvo Pure Electric' follows the vehicle. All remaining services in the maintenance programme can then be used by the new owner in accordance with these terms and conditions.

#### 5. Disclaimer

This maintenance programme Volvo Care Offer 'Service & Maintenance for Volvo Pure Electric' does not include any obligation on the part of any Volvo retailer or Volvo Cars to reimburse the vehicle owner in any way for costs, loss of income, loss of time or any other damage caused by the vehicle being temporarily handed over to the workshop for maintenance, or by the vehicle not being able to be used during the period in which it has been handed over to the workshop for scheduled maintenance. Nothing in these terms and conditions shall exclude, limit or modify any warranty, guarantee, term or condition, right or remedy implied or imposed by applicable law which cannot be legally excluded or limited.

#### 6. Applicable Laws and Disputes

In the event of any dispute concerning the interpretation or application of the Volvo Care Offer 'Service & Maintenance for Volvo Pure Electric', the parties shall seek to resolve this by mutual agreement. The Volvo Care Offer 'Service & Maintenance for Volvo Pure Electric' shall be governed by the laws of the country of first purchase of the vehicle and in the event of any dispute the competent national courts shall have jurisdiction.

# V O L V O

Some of the information in this brochure may be incorrect due to changes to the product specifications introduced after the brochure was published, such as consumption figures. Volvo Car Belux reserves the right to make changes to the prices, colours, materials, specifications and models at any time without prior notice. The images shown are for information purposes only and may differ from the actual product. Certain equipment, options or accessories described or shown are available at an additional cost. All list prices in this brochure are recommended resale prices. VAT applicable is 21% for Belgium and 17% for the Grand Duchy of Luxembourg. Ask your Volvo distributor for the latest information before ordering.

The prices for accessories always include fitting (unless otherwise specified) and (where applicable) Recupel (for Belgium) or Ecotrel (for Grand Duchy of Luxembourg). Recommended prices for winter wheel kits (composed of 4 complete winter wheels with rims and tyres) always include environmental contribution (Recytyre for Belgium), but without fitting and software update (if needed).

Environmental contribution included.

A 4-year data subscription for use of Google services and all apps is included in the retail price of the car. After that period, a paid extension of the data subscription will be available or you can share your data via your smartphone.

Environmental information [Royal Decree 19/03/2004]: all self-respecting Volvo drivers put safety first.  
R.P.: Florent Andrieu - Registered address/head office: Volvo Car Belgium nv, Avenue John Kennedy 25,  
B-9000 Ghent - Place of business: Volvo Car Belux - VAT no.: BE 0420.383.548

VOLVOCARS.BE/LU  
2024 - V06.MY24

